

## The Panasonic Proprietary Telephone Line-Up

### Digital Telephones

#### KX-DT346

- Digital Proprietary Telephone
- 6-Line Back-lit Display
- 24-Programmable Keys
- Full Duplex Speakerphone
- USB Connection (optional)
- Optional Bluetooth® module



#### KX-DT343

- Digital Proprietary Telephone
- 3-Line Back-lit Display
- 24-Programmable Keys
- Full Duplex Speakerphone
- USB Connection (optional)
- Optional Bluetooth® module



#### KX-T7667

- 1-Line Display
- 12-Programmable Keys
- Speakerphone



#### KX-NT303

- Add-on Key Module (12 Co Keys)



#### KX-DT390

- Digital DSS Console (60 DSS)



### Analogue Telephone

#### KX-T7710

- Proprietary Telephone
- 8-Programmable Keys
- Modem Data Port
- Message Waiting LED
- Ideal as an office or hotel room phone
- One-touch Button Panel



#### KX-DT301

- USB Model
- KX-DT343 / KX-DT346 Telephone
- Supports 1st Party TAPI Application



# Panasonic

ideas for life



Office Communication  
Systems

KX-TDE100  
KX-TDE200

New Telephony Systems Offering Solid IP Solutions

**DECT 6.0**

# The Panasonic Full-IP PBX Debuts Together with Versatile New IP Phones.

## A Pure IP PBX for an IP Platform and Traditional Telecom Lines.

Today's offices are shifting from traditional telecom systems to low-cost, flexible IP systems that take full advantage of the rapid growth in IP applications and globalization. The KX-TDE100 and KX-TDE200 can be used to construct a full-IP telecom system, making them a perfect match for these new communications systems. The KX-TDE100 and KX-TDE200 offer new, standard-equipped IP functions that boost efficiency and lower communication costs.

They also include convenient and highly effective features such as wireless operation, voice mail and CTI. For companies planning to switch to a full-IP system, Panasonic IP-PBX systems offer a scalable, easy-to-use platform that adapts to a wide range of business fields for future expansion. In addition, these models also support traditional telecom lines, so they allow IP systems to be integrated with conventional telecom systems such as ISDN and analogue lines. Depending on the

office environment, it may be difficult to switch an existing traditional telecom line to a full IP system all at once due to time and cost restrictions. The KX-TDE100 and KX-TDE200 respond flexibly to needs like this. By changing the main board in the current TDA series, a new system can be easily constructed. This lets the KX-TDE100 and KX-TDE200 provide optimal solutions for companies that want to smoothly migrate to an IP system while continuing to use their existing telecom network.

## Integrated Office Solutions and Business Productivity.



## Key features of the Panasonic KX-TDE100/TDE200

### Full-IP compatibility

Low-cost, flexible IP system construction

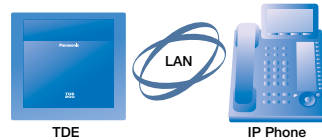

Using an IP network to reduce costs.

### Outstanding versatility

Because the KX-TDE100/TDE200 are compatible with existing infrastructure (Analogue/ISDN lines, etc.), they are ideal for offices that want a phased migration to an IP system.



Partial incorporation of an IP system into a traditional telecom system. Switching to a full-IP system in the future.

### Attractive system for TDA users

The functions of the newest TDE series can be used by simply replacing IPCMPR Card.

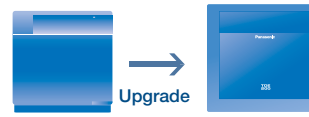

### Easy setup and maintenance

The TDE uses the same PC programming software operation that is used in the TDA series and supports multi-site programming. It is able to manage up to four TDEs on the network by PC operation.

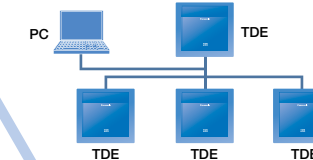

Central management of remote sites.

### Panasonic PBX IP Migration Strategy

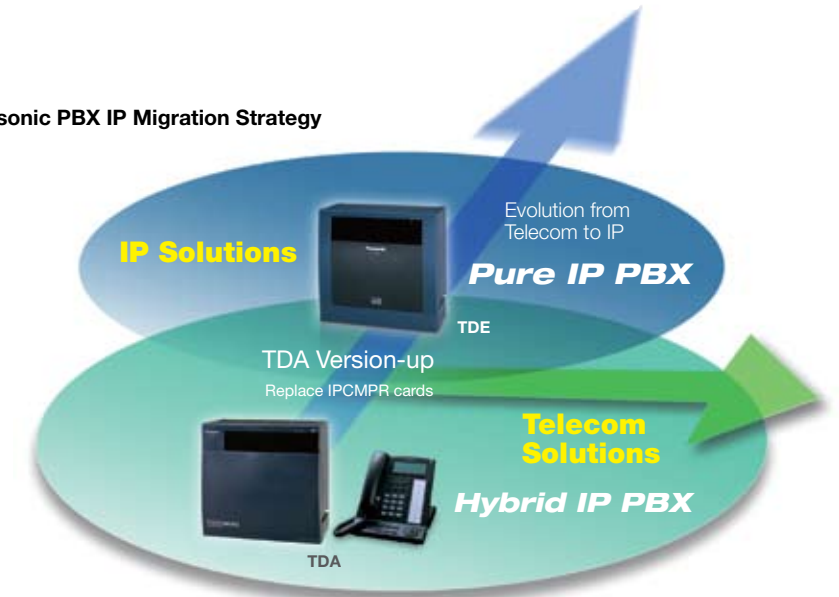

## Panasonic TDE Series... Power Enhancing Features

The KX-TDE series Pure IP PBXs are advanced corporate communication systems providing IP telephony features and functionalities over both local and broadband IP networks.

They are an ideal communication platform to help customers solve all their business telephony needs today as well as in the future as they embrace full IP telephony, empowered with the latest SIP technology.



### New IP Features in the TDE

- **Full-IP compatibility**
  - Up to 64 IP-proprietary telephones and 32 IP-trunks with the optional DSP card.
  - Up to 128 standard SIP phones.
- **Support for the new IP-PT KX-NT300 series**
- **Fully equipped with KX-TDA functions and solutions**
- **Server connection**
  - The TDE series will connect DHCP/SNTP servers and SNMP manager as either client or agent.
- **Enhanced walking extension**
- **Easy Maintenance**
  - Using a PC Programming Software, with the same method as the TDA series.
  - 2 Built-in LAN ports

### Ideal for TDA Series users

- Uses TDA's option cards and inherits its easy operation.
- Simple setup
- Easy maintenance
- Full support of TDA features
- Upgradeable to TDE by changing the main card (IPCMPR card) in the TDA

### Server connection

The TDE supports the connection of the following, allowing for enhanced efficiency and record keeping.

- DHCP client for TDE
- SNMP Agent/Alarm
- SNTP client

### Enhanced walking extension (Hot Desking)

It is possible to use any extension, and to have your extension setting available whenever you want it. This is a very useful feature when...

- You move locations
- There is no specific desk for you to use.

### Easy Maintenance

- Using the web interface of the Phone Manager software, both telephone users and system administrators can perform easy changes to the system.
- 2 Built-in LAN ports

### Best match with the new KX-NT300 Series for IP telephony

- Self labelling display (Only KX-NT366)
- Bluetooth® Module for hands-free talking
- Add-on 12-key/60-key modules (Only KX-NT346 and KX-NT343)
- Peer-to-Peer connection
  - Reduced load on VOIP resources in the main PBX unit
- High sound quality (G.722 codec) between KX-NT300 series



### Full-IP compatibility

Allows the use of an IP trunk line (H.323) and an SIP trunk, IP-PTs, IP softphone, and SIP extension.

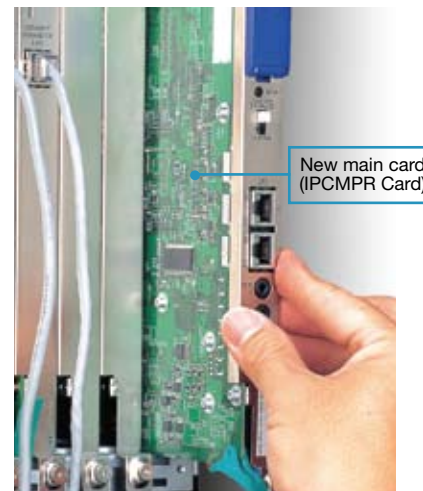
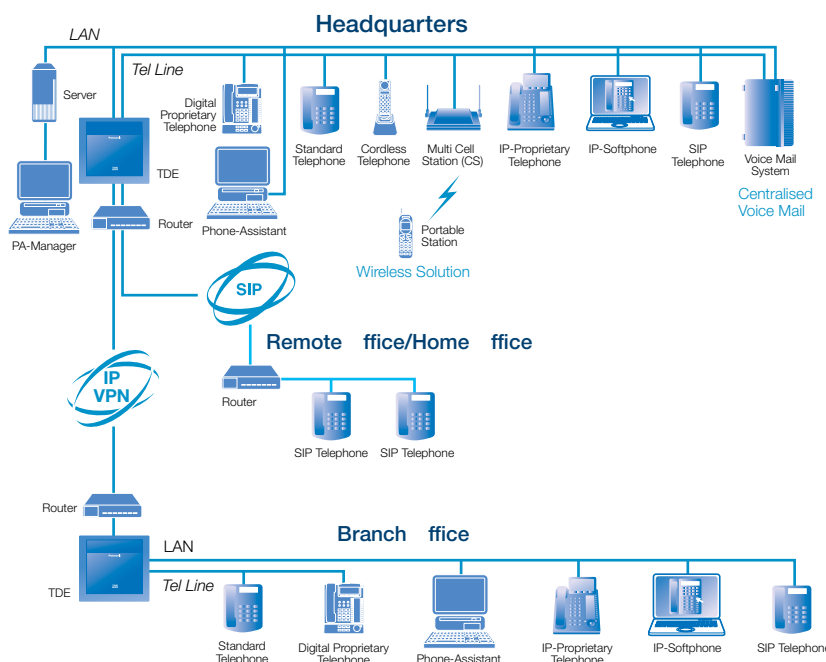

Upgrade from TDA to TDE

### TDE and TDA Comparison

	Item	KX-TDA Series	KX-TDE Series
IP Trunk	H.323	YES (VPN)	YES (VPN)
	SIP	NO*1	YES
IP Extension	MGCP	YES	YES
	SIP	NO	YES
	Peer-to-Peer	NO	YES
Proprietary Telephone	NT300 Series	YES*2	YES
	DT300	YES*3	YES*4
	T7600 Series T7400 Series	YES	YES
Linkage with server	DHCP	NO	YES
	SNMP	NO	YES
	SNTP	NO	YES
Wireless (DECT)	8 CH CS	YES*5	YES

\*1 SIP Trunking only with KX-TDA30 and KX-TDA3450  
 \*2 KX-TDA100/200/600 V.5.0  
 KX-TDA30 V.4.0 + KX-TDA3470  
 KX-NT366 self labeling function will not be supported  
 \*3 Bluetooth will be supported with KX-TDA30/100/200/600 V.5.0  
 \*4 Bluetooth will be supported with KX-TDE V.2.0  
 \*5 KX-TDA 30/100/200/600 V.5.0

# Proprietary Telephones for an Easy Touch

## Panasonic's IP Telephones... Attractive Features

Ergonomic designs offer the ultimate in easy operation.  
Literally filled with comprehensive IP telephony functions.



### New Features

- **Stylish Universal Design concept**  
Free tilt angle (Double tilt adjustment for phone base and LCD). The phone base and LCD tilt to easy-to-view angles.
- **Self labelling (Only KX-NT366)**
- **Hands-free talking with a Bluetooth® Headset**
- **Peer-to-Peer Connection**
- **Navigator Key**
- **Second Ethernet Port**
- **Flexible CO Buttons**



### Peer-to-Peer Connection

Direct communication between KX-NT300 series is available after the communication was established by TDE series. And Peer-to-Peer communication reduces network traffic and PBX's resource.

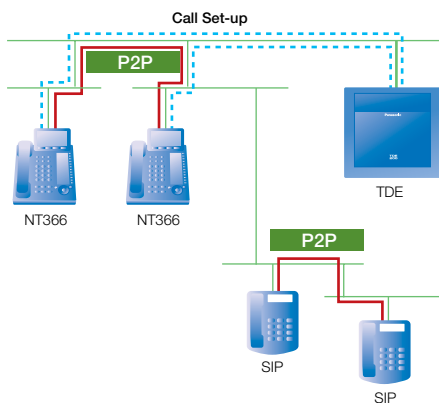

### Self Labelling LCD (Only KX-NT366)

The KX-NT366 IP-proprietary telephone features 12 flexible buttons, with an LCD screen next to the buttons. Each item can be named on the LCD screen through personal or system programming to reflect the function of its corresponding flexible button. Plus, a total of 48 functions can be assigned to the 12 flexible CO buttons. Pressing the "NEXT PAGE" key toggles between pages.

\*These features are available only on the KX-TDE100 and KX-TDE200.

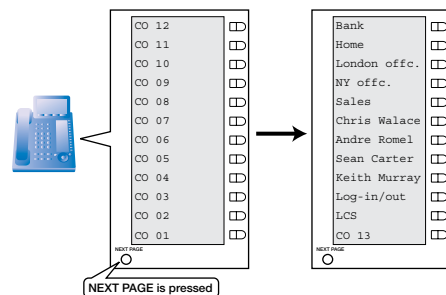

### Hands-Free Communication with a Bluetooth® Headset

Mounting the KX-NT307 lets you connect a commercially available Bluetooth® headset for hands-free communication (Answer a call/End a call/Voice communication). This makes it possible to operate a PC during conversations and to communicate comfortably at a distance from the telephone.



### New IP Proprietary Telephone Line-up

#### KX-NT366

- 6-Line Backlit Display
- 4 x 12-Self Labelling, Flexible CO Buttons
- Speakerphone
- 2 Ethernet Ports (100 Base-T)
- Power-over-Ethernet (PoE)
- Bluetooth® Module (Option)

6-Line LCD & Self Labelling



#### KX-NT346

- 6-Line Backlit Display
- 24 Flexible CO Buttons
- Speakerphone
- 2 Ethernet Ports (100 Base-T)
- Power-over-Ethernet (PoE)
- Bluetooth® Module (Option)
- Add-on 12-Key Module (Option: KX-NT303) OR Add-on 60-Key Module (Option: KX-NT305)

6-Line LCD



#### KX-NT343

- 3-Line Backlit Display
- 24 Flexible CO Buttons
- Speakerphone
- 2 Ethernet Ports (100 Base-T)
- Power-over-Ethernet (PoE)
- Bluetooth® Module (Option)
- Add-on 12-Key Module (Option: KX-NT303) OR Add-on 60-Key Module (Option: KX-NT305)

3-Line LCD



### More Features

- **Navigator Key**  
The Navigator key allows fast, one touch access to multiple phone system functions. The ergonomically designed navigation key makes it easy to go through phone system feature menus.
- **Second Ethernet Port**  
Reduce cable clutter on your desktop and reduce cost of cabling by using the built-in second Ethernet port to connect your personal computer (or other IP network device) to the IP network without the cost of additional cabling.
- **Flexible CO Buttons**  
One-touch function access Flexible CO Buttons save time and effort. These keys can be used to store telephone numbers, or access frequently used phone system features.
- **Add-on 12/60-CO Key Module Connection**  
Add-on 12/60-CO Key Module works as not only DSS keys but also Flexible CO Buttons. KX-NT303/NT305 Add-on 12/60-CO Key Module is connected directly to KX-NT346 and KX-NT343. Self-Labeling model KX-NT366 does not support this Module.

### Options

#### Add-on Key Module

##### KX-NT303

- Add-on 12-Key Module (For KX-NT346 and KX-NT343 only)



##### KX-NT305

- Add-on 60-Key Module (For KX-NT346 and KX-NT343 only)



#### Bluetooth® Module

##### KX-NT307



## Panasonic Wireless Solutions... Flexible Communication

The TDE's wireless solutions enhance mobility and flexibility for offices, healthcare, big shops, etc.



### Wireless for TDE series

Panasonic Office Communication Systems allow wireless communication over an extended range by using multiple cell stations that boost the flexibility and mobility of your wireless handset. Using the Wireless XDP, you can set your wireless telephone to have the same extension as your desk phone, and then receive calls even when you are away from the desk. You are always there, ready to receive customer calls, and make the most of every business opportunity that comes along.

### Benefits of Wireless Telephone Integration

- Up to 128 handsets can be connected to one system
- Secure high-quality speech reproduction and excellent reliability
- Caller ID name and number compatibility\*
- Programmable multiple ring patterns, including vibrate mode

\*Requires subscription to a fee-based telephone service.



### DECT



#### Business Class Wireless DECT mobility for Your Panasonic PBX System

The Tough Type KX-TD7696 handset meets strict dust- and splash-resistant IP54 standards and offers a vast array of business telephony features. The KX-TD7695 DECT handset combines small size and light weight with a host of powerful business telephony features. And the KX-TD7685 is an excellent choice for users who want great basic performance at a lower cost.

\*The KX-TD7685, KX-TD7695 and KX-TD7696 must be connected to a compatible Panasonic Phone System.

#### As for KX-TD7696 Tough Type Model

- IP5\* = Dust resistance (Protection from dust penetration to a level that does not interfere with the operation of the handset)
  - IP\*4 = Water resistance (Protection against splashing water)
- The Panasonic KX-TD7696 DECT Handset complies to UKAS IP54 testing standards.
- Impact absorbing rubber is adopted around the KX-TD7696.
  - The cabinet (outer plastic covering) is also used impact-touch materials.

## DECT 6.0

### KX-TD7685, KX-TD7695 and KX-TD7696

- 6-line blue LCD backlight
- Illuminated keypad
- Multiple language display
- Speakerphone
- Programmable soft keys
- PBX functionality support\*1

- 100 entry phonebook
- Headset compatible
- 9 polyphonic ringer melodies and 6 ringing patterns
- Vibrate alert\*2
- Meeting mode

\*1The KX-TD7685/7695/7696 must be connected to a compatible Panasonic phone system. \*2Vibrate mode only for KX-TD7695/7696

Compact Business Model



KX-TD7695

Basic Model



KX-TD7685

Tough-type Model (IP54 compliant)



KX-TD7696

Impact-absorbing rubber installed on the entire circumference

External cabinet made of impact-resistant material

### Cell Stations



KX-TDA0155  
Cell Station 2 speech path



KX-TDA0156  
PPT I/F Cell Station 4 speech path CS I/F



KX-TDA0158  
Cell Station 8 speech path

#### Maximum Terminal Equipment

The following shows the number of each terminal equipment type supported by the PBX

Terminal Equipment Type	KX-TDE100	KX-TDE200
Basic CS	32	32
PS	128	128

\*KX-TDA0158 counts as 2 Cell Stations

#### DECT Required Equipment and Maximum Number of Calls

CS	Connection Card	Maximum Calls	Compatible PSs
KX-TDA0155	DHLC,DLC	2	TD7685 TD7695 TD7696
KX-TDA0156	Cell Station I/F	4	TD7696
KX-TDA0158	DHLC,DLC	8	

## Providing customers with intelligent call handling through Computer Telephony Integration (CTI).

Phone Assistant enhances personal, team and business productivity.



### CTI from Panasonic

Panasonic CTI comprises both 1st Party CTI (via USB connection) and 3rd Party CTI (via LAN connection), to provide customers with unique Panasonic applications, such as Phone Assistant/ACD report server, and other customized software utilities employing TAPI/CSTI interfaces. Connecting a PC to a DPT, or connecting a CTI Server to our PBX, enables extension users to make use of advantageous features by using the stored data in the PC or the CTI Server.

The features that are available through CTI depend on the CTI application software used on the connected PCs.

#### 1. Using USB – 1st Party Call Control

A PC is connected to a DPT via a USB port (USB module) on the DPT. The PC monitors and controls the DPT.

#### 2. Using LAN – 3rd Party Call Control

A CTI Server is connected to the PBX using the LAN port of an IPCMPR card as a CTI interface. PCs monitor and control the PBX via the CTI Server.

#### Application Programming Interface (API)/Protocol

The following interfaces are required for 1st and 3rd Party Call Control.

Type	API/Protocol
1st Party Call Control	TAPI 2.1
3rd Party Call Control	ECMA CSTA Phase 3 TAPI 2.1

### Phone Assistant Status for Supervisors and Team Leaders - Easy Call Monitoring

Business managers, supervisors, and team leaders can benefit from real-time monitoring of all team member telephony communication activities. The Phone Assistant Status Pro application allows monitoring of up to 256 users - (combination of phone assistant users or normal phone extensions) with complete presence and availability information - perfect for any informal call centre.

Status users can pick up any ringing call being monitored, as well as silently Listen-in, Barge-in, or Take over a call. In addition - supervisors can even record a selected call - if required. Monitored extensions can also be flagged for easy identification - e.g. when monitoring a new employee or an agent in training.

#### Monitor employee phone status / usage

Phone Assistant Status Pro users can monitor all configured incoming calls. Monitoring allows Status users to see not only all telephony activities but also settings of the monitored users, e.g. call forwarding, absent messages, etc.

#### Extended reporting capabilities

The software supports extensive reporting capabilities with built-in reports as well as the ability to customize reports in order to keep track of all company telephony communications activities, such as the following.

- Status of monitored extensions
- History of all calls
- Output of call logs as CSV files



#### System Connection Diagram

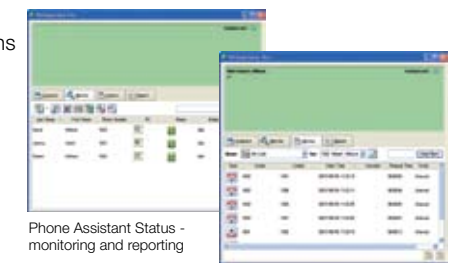
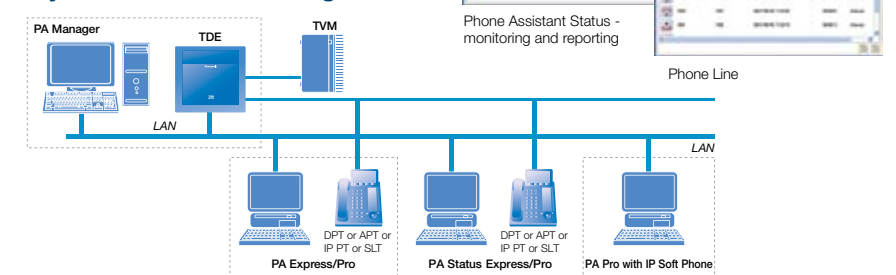

Phone Assistant Status - monitoring and reporting

Phone Line

### Phone Assistant for Personal Productivity - Easy Access to Phone Features

By providing on-screen call related information like Caller ID, Calling Party's Name and allowing users to simply point-n-click or use keyboard shortcuts to quickly handle calls - users are able to do more in less time, thereby increasing personal productivity.

#### Dial easily through your database

Users can create their own business and private contacts, show the presence and availability of all co-workers or they can simply dial external business contacts by double-clicking. The software can utilise Outlook address books for contact lists.

#### Integration with IP Camera

Panasonic IP Camera can also be integrated, allowing users to answer a doorphone and open the door after viewing the IP camera video feed on screen.

#### Record conversations directly into Voice Mail (TVM50/200)

Allows Phone Assistant users to record the conversation that they are having with a caller directly into their voice mailbox.



Phone Assistant - intuitive user interface

View presence & availability.

### Phone Assistant Manager for the tool of IT Administrators - Easy Maintenance

IT departments can use any networked PC with a standard web browser to use the Phone Assistant Manager to create and set Phone Assistant users as well as make typical configuration changes to their TDA/TDE IP PBX. Using this tool, customers can use self help to modify simple system and extension settings like:



- Modify System Date/Time and Holidays
- Add/Modify PBX speed dial numbers
- Set system wide absent messages
- Set Call Forwarding, Do-Not-Disturb, Call Waiting etc, and
- Assign flexible programmable keys

With a properly configured office IP network, authorised IT department personnel can even remotely access and configure basic TDA PBX settings from anywhere in the world they have access to the office network.

#### Phone Assistant Express/Pro Specifications

Features	Express V1.7	Pro V1.7
User Capability	5 for TDA30, 10 for TDA100/200, 20 for TDA600	max 256 Users (Pro trial version : 2 for TDA30, 4 for TDA100/200, 8 for TDA600)

#### Software List

Product Name	Model	Description
Phone Assistant Pro	KX-NCS1101	Software to control a telephone. License is required. KX-NCS1101 is for 1 license. KX-NCS1105 is for 5 licenses. KX-NCS1110 is for 10 licenses.
Phone Assistant Status Pro	KX-NCS1201	Software to monitor a call. A license is required. KX-NCS1201 is for 1 license.
Phone Assistant IP Soft-Phone Plug-In Module	KX-NCS9101	IP Soft-Phone Plug-In Module for PA Pro and PA Network Console. A license is required. KX-NCS9101 is for 1 license.
Phone Assistant Manager	KX-NCS1301	

#### Phone Assistant Status Express/Pro Specifications

Features	Express	Pro
User Capability	max 3 Users	max 8 Users
Extension Monitor	max 5 Extensions	max 128 Extensions

# Informal Call Centre Systems

Bring your distributed offices closer together with the ease of IP.

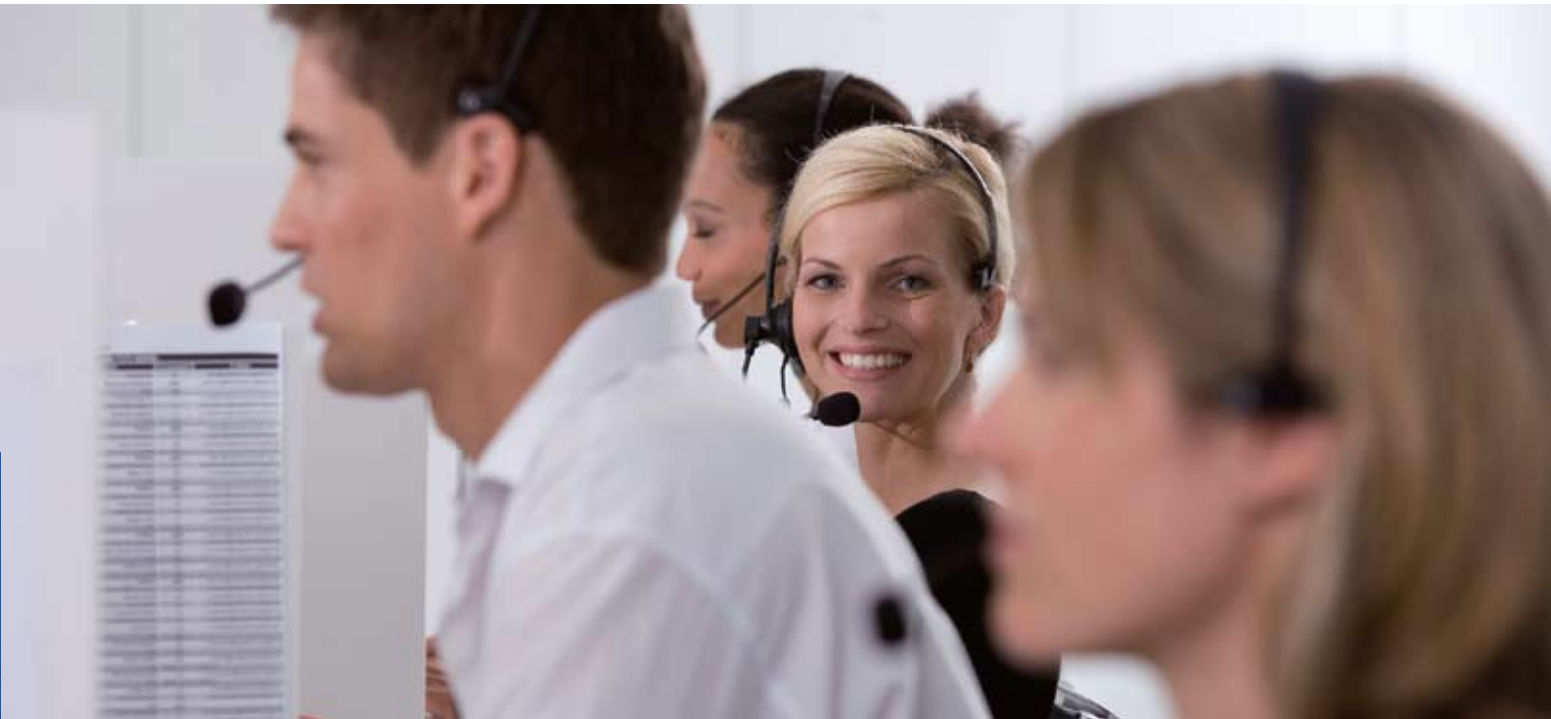

## ACD Report Server

**KX-NVC200**

ACD Report Server is designed to bring advanced call centre functions to users of Panasonic PBX systems, such as the KX-TDA100/200/600, KX-TDE100/200. This provides useful functions real-time monitoring and call centre performance reports, and agent log-in. Offentimes, the difference between gaining or losing a new customer can hinge on a single telephone call. Panasonic's call centre solution makes sure that every telephone call works in your favour.

Screen of ACD Report Client

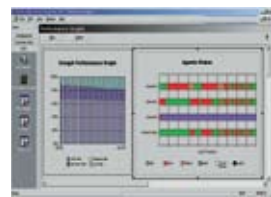

Performance Graphs



ACD Monitor



ACD Report

### System Connection Diagram

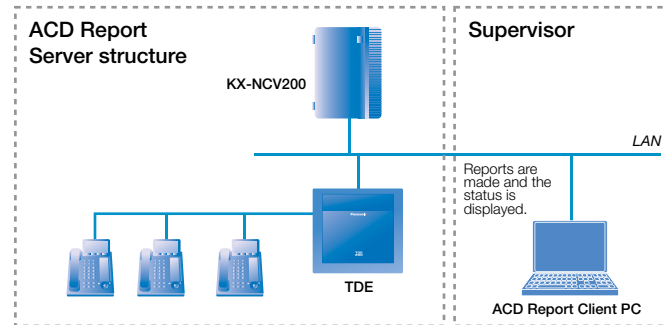

#### Optional Accessories

KX-TVM204	4 - Port Digital Expansion Card
KX-TVM296	Modem Card

## IP Softphone

**KX-NCS4208**

### Mobility

Enjoy smooth communications through your PC with virtually the same level of functions that you would have if you had brought your office phone with you.

### Transparent Integration

You can administer and operate IP telephones just like other extension telephones.

### Flexibility

IP technology lets you send data and voice over the same line.

### Around the world

For example, communicate with colleagues around the world with low cost and high efficiency.



### In home offices

For example, gain the same kind of benefits as if you had your own call centre right in your office at home.

### Real time Monitor

ACD (Automatic Call Distribution) Monitoring

### Log Report

Trunk Call Report/ System Report

### Real time Analysis

Performance Graphs

### Voice Mail

## Voice Processing System

**KX-TVM50/TVM200**

The human voice is still the best way to communicate. And with the KX-TVM50 and KX-TVM200, Panasonic introduces two feature-packed voice processing systems (VPS) designed for efficient communication.

The KX-TVM50 and KX-TVM200 each offer automated attendant, automatic call routing, and message notification, and each can be customised to your needs.

### System Connection Diagram

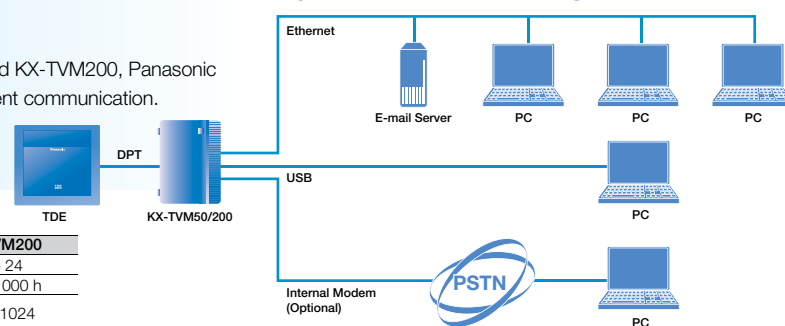

KX-TVM50/200 Specifications	KX-TVM50	KX-TVM200
Number of Ports	2 to 6	0 to 24
Voice Storage	Initial: 4h Max.:8h	Max. 1000 h
Number of Mailboxes (including System Manager and Message Manager mailboxes)	Max. 64	Max. 1024
Number of Messages	Unlimited	
Memory Media	Flash Memory	HDD
Remote Modem	Modem Card (Max. 33,600 bps)	

#### Optional Accessories

KX-TVM50		KX-TVM200	
KX-TVM503	2 - Port Digital Expansion Card	KX-TVM594	LAN Interface Card
KX-TVM524	Memory Expansion Card	KX-TVM296	Modem Card
KX-TVM204	4 - Port Digital Expansion Card	KX-TVM296	Modem Card

### IP Softphone on PC Screen

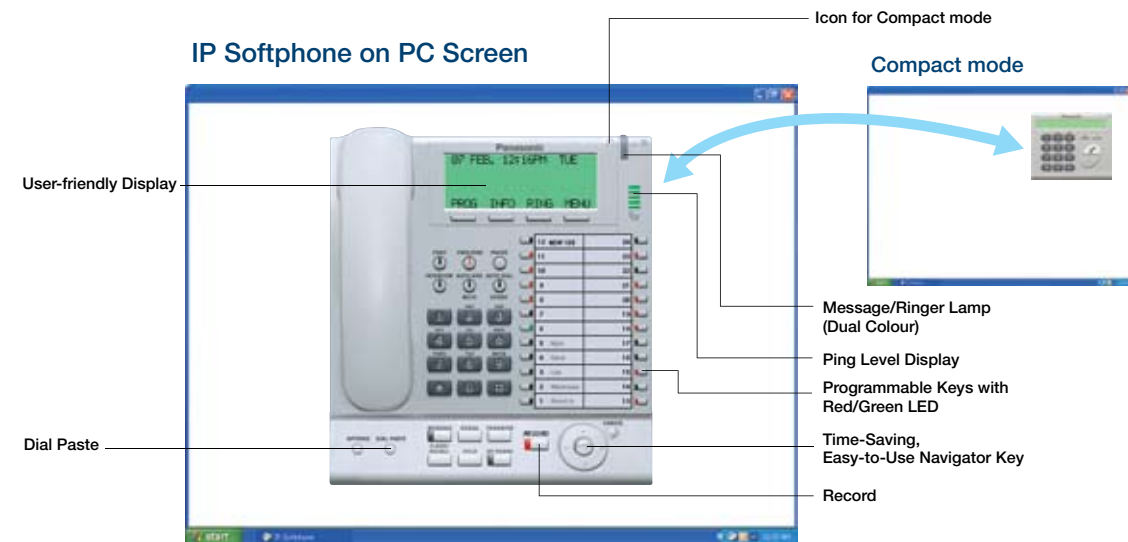

#### Softphone Specifications

Alphanumeric Display (LCD)	6 lines x 24 characters
Programmable Keys with Dual Colour LED	24
Direct Station Selection (DSS) Keys with Busy Lamp Field (BLF)	Yes
Dial Paste	Yes
Record	Yes
Station Speed Dial	10 Numbers
USB Handset with Audio Ringer on PC	Yes
Peer to Peer Connection with NT300 Series	Yes

# Panasonic Office Communication Systems Are Ideal for Any Business, Any Location

For the majority of businesses, personal contact with the customer is a significant factor for success. The telephone system is at the heart of all communications – without any concern as to how the communication is conveyed: via IP, by traditional telephony or by employing wireless technology. What is crucial for businesses is quality and reliability. Panasonic provides wide variety of solutions to cover any individual requirements.



## Hotel

The Hospitality market requires the communications system to be flexible, economical, and easy to use, with maximum reliability and adaptability for the individual needs. The possibility of PC integration to allow guest room billing and system management has also become a requirement of this sector. The TDE Systems are perfectly equipped with all these necessary hospitality features and solutions.

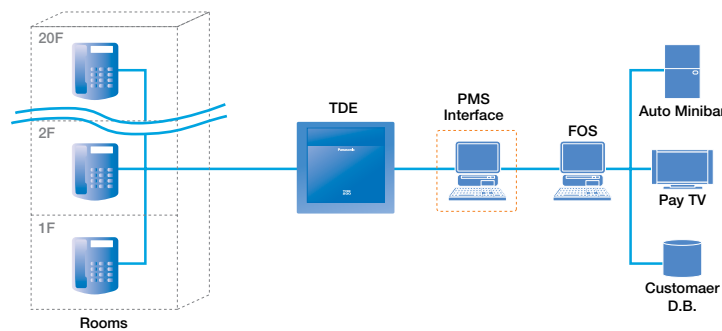

## Sales

In today's competitive world, personal contact becomes ever more important to the customer. Customer satisfaction, maximum flexibility and accessibility provide the crucial lead in this sector. With a solution from Panasonic, everything that you need is already built in as standard.

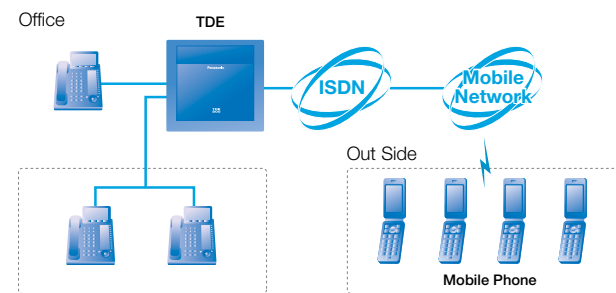

## Health Service

A telecommunication system in nursing facilities and resident housing must be consistent above all to the requirements of people in need. Panasonic offers custom-made solutions that can be integrated with computers to support administrative tools and emergency call systems. The investment ensures security by flexible, future-safe technology.

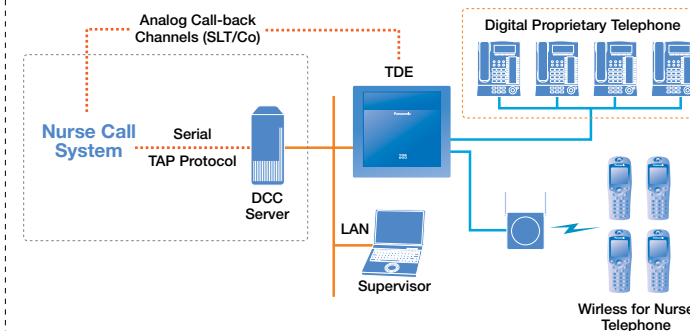

## Customer Service

We all would like to offer our customers the best service we possibly can, and while you might be the best today, what about tomorrow? Panasonic Telecommunication systems offer service-orientated solutions, which can be expanded to meet your customer's needs now and for days to come.

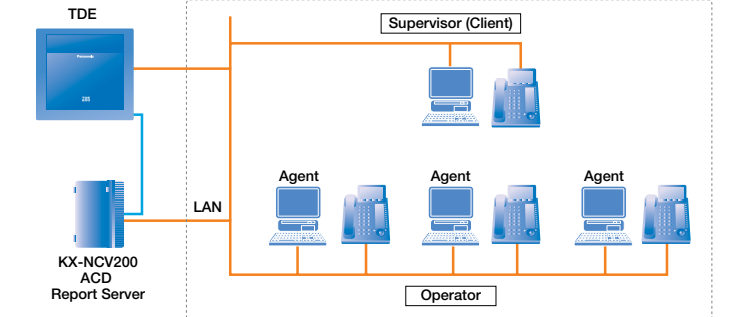

## Administration

Public administrations see themselves today more than ever as service providers. Their services must be carried out in spite of the increasing pressure of cost management for government, council and municipal authorities. Panasonic offers such establishments a telecommunications solution which helps them maintain and keep their costs in check.



## Medical

To be able to work effectively and comfortably in a medical environment, it is necessary that the telecommunication system is adapted perfectly to fit the needs of this type of activity. In the field of health, Panasonic alleviates the continual increase in costs and allows easy integration with life saving technologies.



## Production Enterprises

High flexibility, economy and maximum reliability as well as adjustment to individual needs are important criteria, which telecommunication systems must fulfil. The KX-TDE outshines here as it was developed with manufacturing plants and production departments in mind. With its ultramodern design and future ready solutions, experience a new dimension of efficient communication.



## Logistics

Logistics requires smooth and reliable transport of information. This is why logistics companies have particular requirements when it comes to telecommunications systems. With possibility for integration into modern EDP systems and mobile accessibility, the KX-TDE systems can become the driving force for your business today, tomorrow and in the future.



## Legal

The legal industry of law firms, notaries, attorneys, solicitors etc have specific requirements when it comes to business communication. Attorney client conversation may need to be recorded - or clients may need to be billed for calls. Law firms may prefer to have secure entrances monitored via IP cameras. The KX-TDE addresses all these unique communication needs of the legal industry - yet provides all these and more solutions in a cost effective manner.

